



High Density Signal Connectors

- Straight TBS, R/A TBS, male crimp, Flex SMT, solder bucket, stacking, pin carrier
- Pin size/current: 0.6mm/4 amp
- Pitch: 1.905mm/0.075" on a staggered pitch of 0.953mm/0.0375
- No. of contacts: 20, 50, 77, 102, 119, 128, 152, 202, 253, 303

Markets

Mil/Aero Space, Marine, Rail and Industrial

Ordering Information

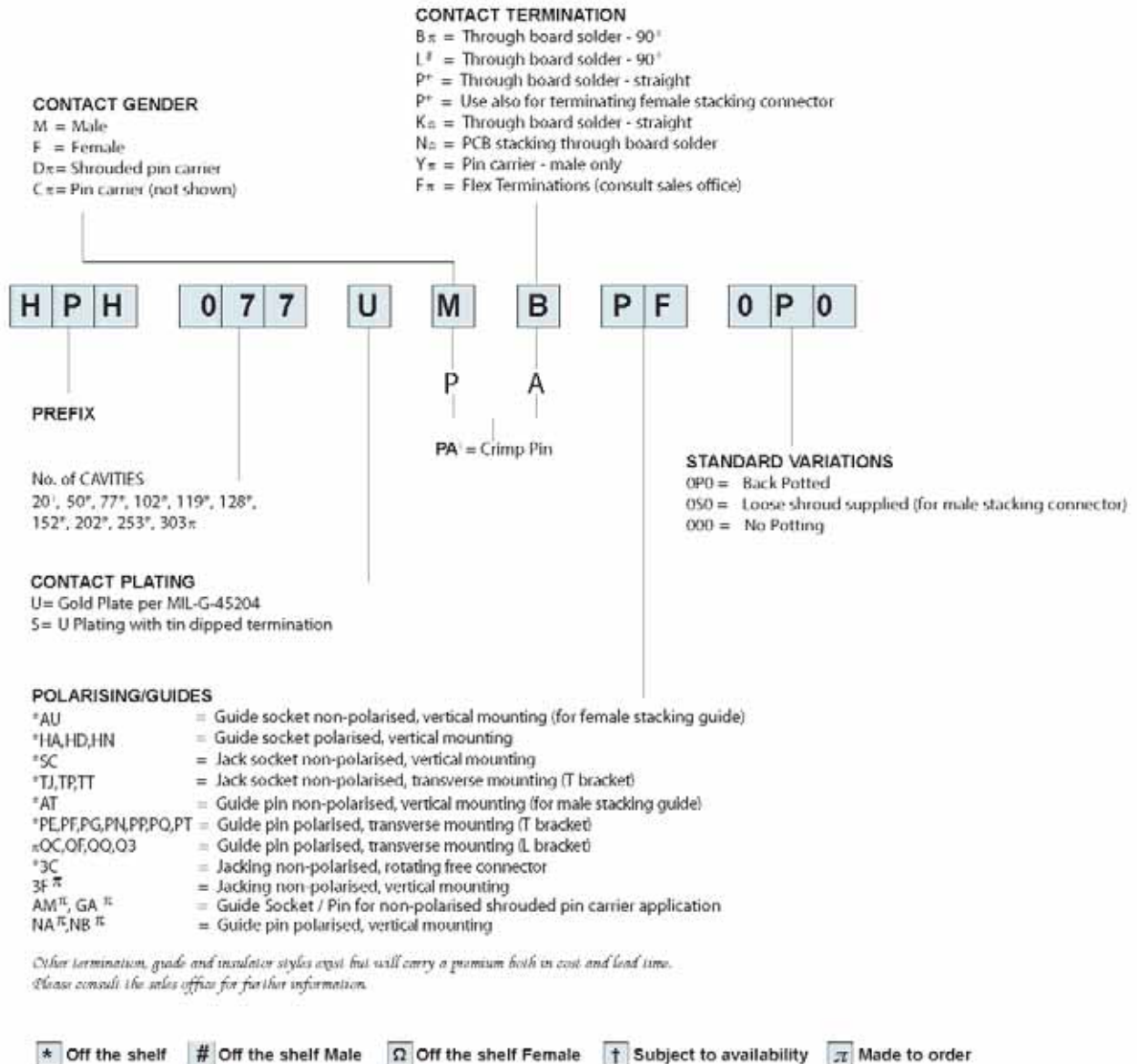

HPH insulators

3 ROW Male Half

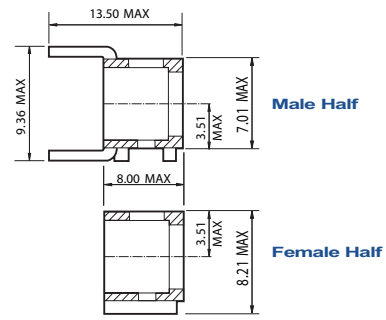
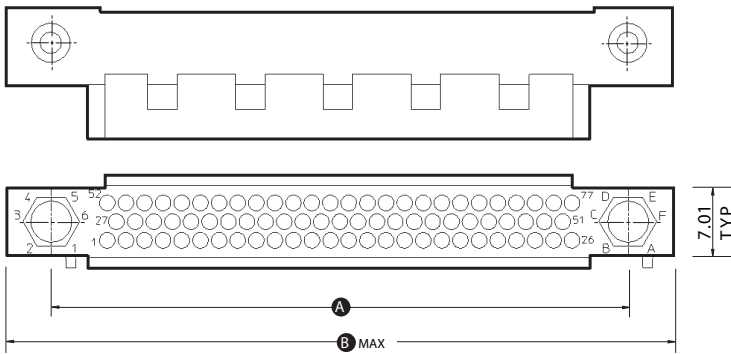

3 ROW Female Half

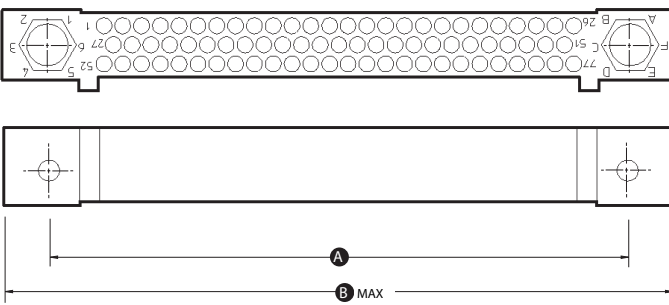

No. OF POSITIONS	20†	50*	77*	119*	152*
Dimension A	22.86 0.901"	41.91 1.65"	59.06 2.325"	85.73 3.375"	106.68 4.200"
Dimension B	32.18 1.267"	51.23 2.017"	68.38 2.692"	95.05 3.742"	116.50 4.586"

- * Off the shelf
- † Subject to availability

4 ROW Male Half

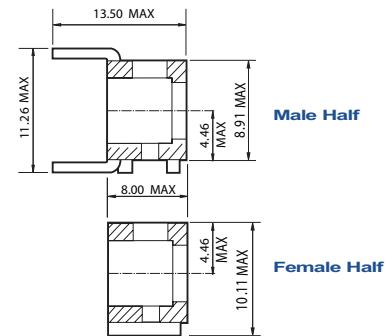
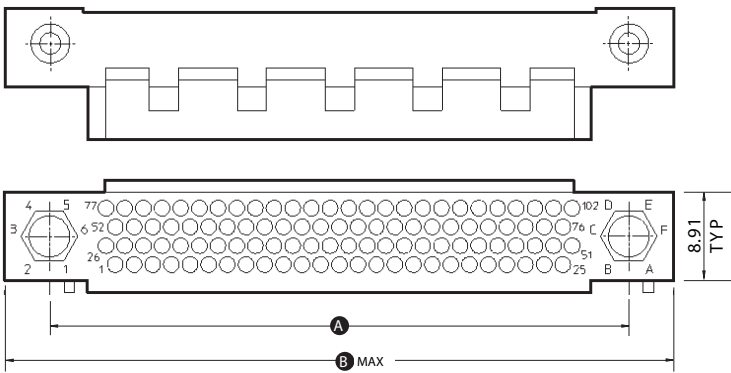

4 ROW Female Half

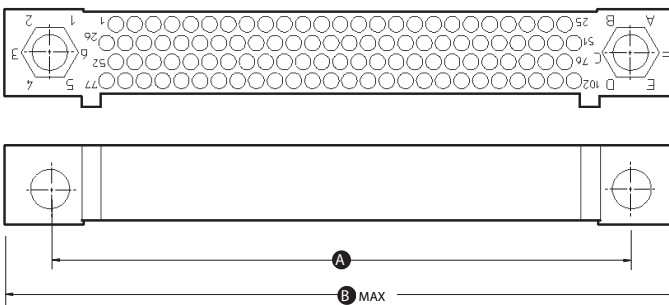

No. OF POSITIONS	102*	202*
Dimension A	59.18 2.330"	106.68 4.200"
Dimension B	68.50 2.697"	116.50 4.567"

- * Off the shelf
- † Subject to availability

Dimensions are in mm

HPH insulators

5 ROW Male Half

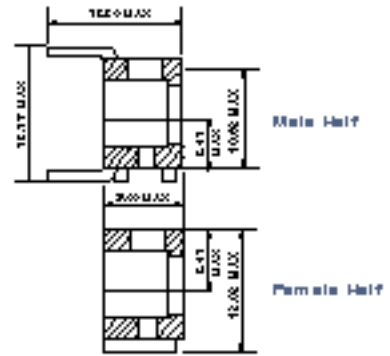
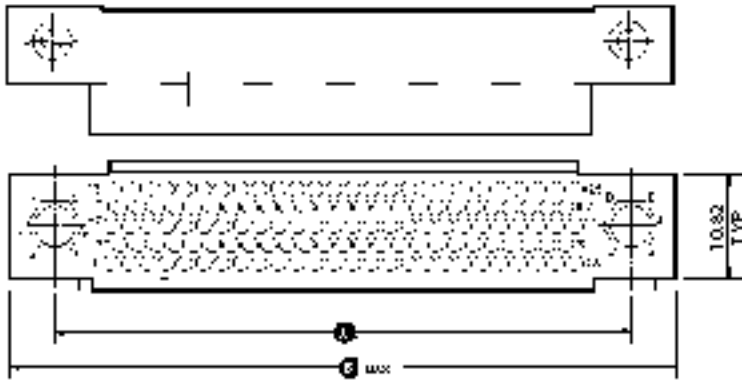

5 ROW Female Half

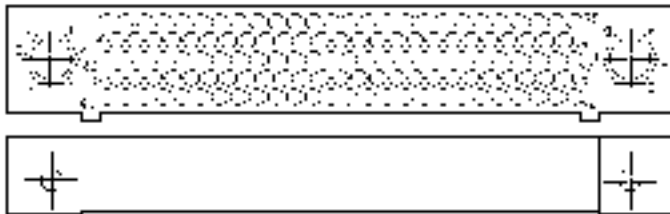

No. of POSITIONS	50°	25°
Dimension A	54.00 2.127"	49.00 1.929"
Dimension B	68.25 2.685"	64.50 2.539"

- ⊛ Off the shelf
- ⊠ Subject to availability

6 ROW Male Half

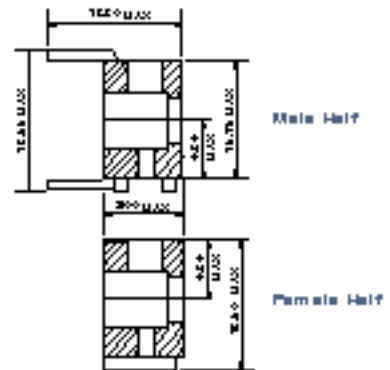
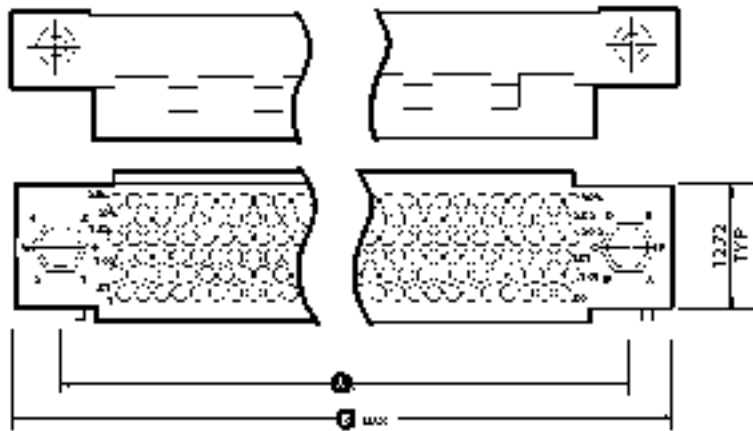

6 ROW Female Half

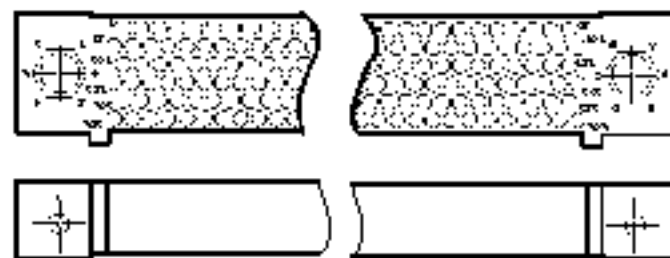

No. of POSITIONS	20°
Dimension A	49.00 1.929"
Dimension B	64.50 2.539"

- ⊛ Off the shelf
- ⊠ Subject to availability

Dimensions are in mm

HPH insulators/Pin Carrier/guides

SHROUDED PIN CARRIER

Shrouded Pin Carrier

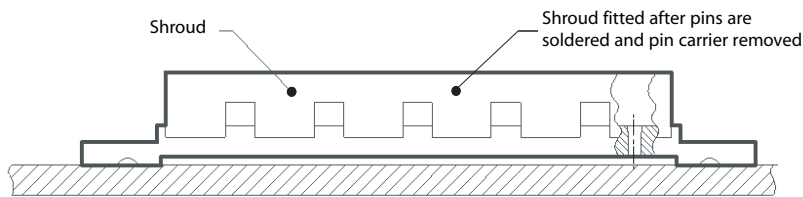
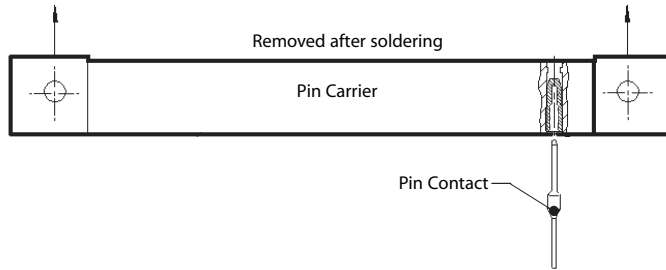

Shrouded insulator shown with pins and guides.
Ready to mate with standard female connector fitted with suitable female pin carrier guides.

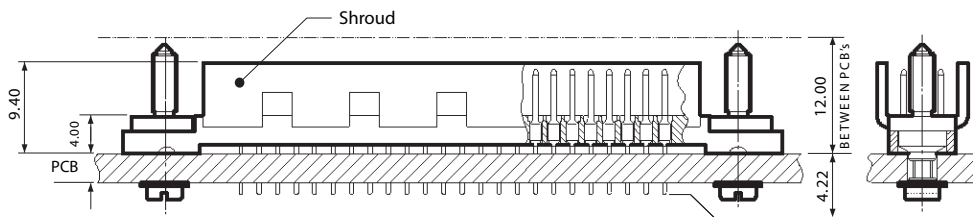

SHROUDED PIN CARRIER GUIDES

STYLE AM

Non Polarised Guide Socket
Vertical Mounting

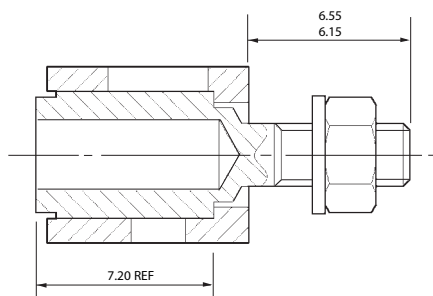

STYLE 9A

Non Polarised Guide Pin
Vertical Mounting

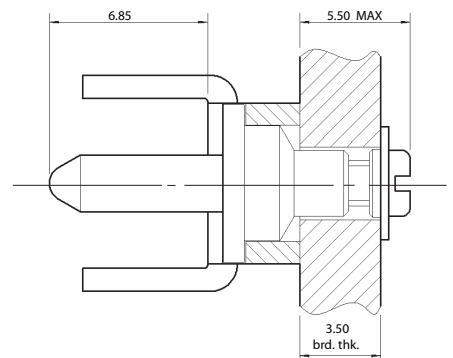

Dimensions are in mm

HPH stacking insulators

STACKING CONNECTOR APPLICATION

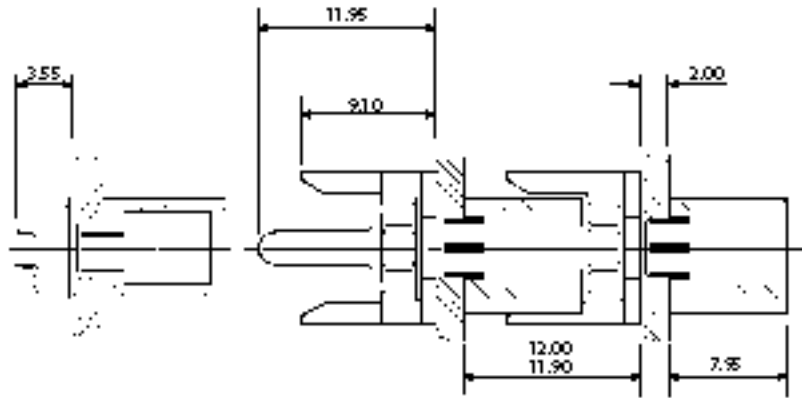

Fixed stacking height

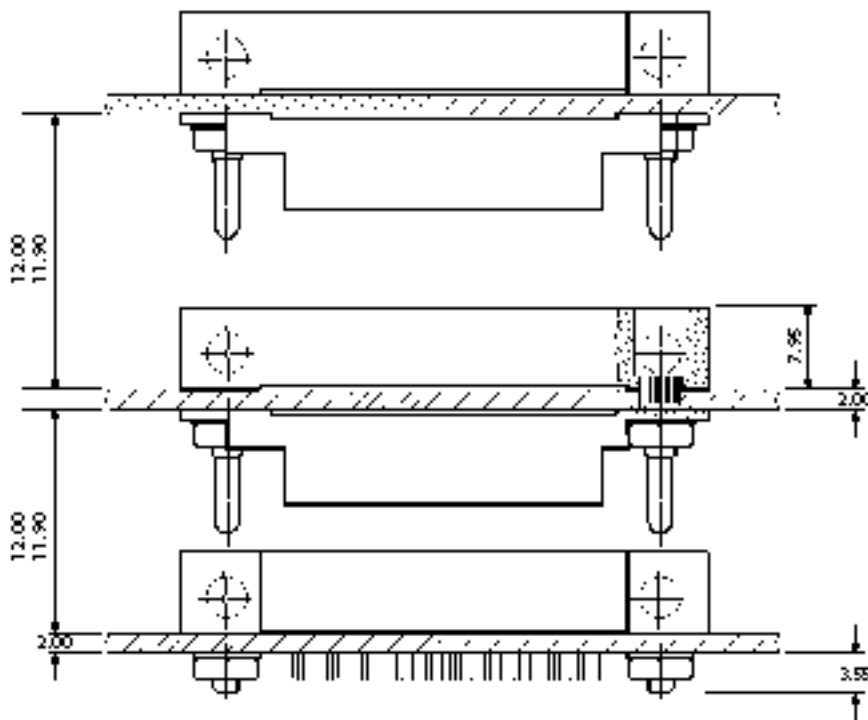

Stacking connectors are currently available in 50, 77 & 102 way only.
For insulator dimensions please refer to previous pages

If you have further requirements please contact our sales offices.

HPH standard PCB terminations

FEMALE 90° PCB

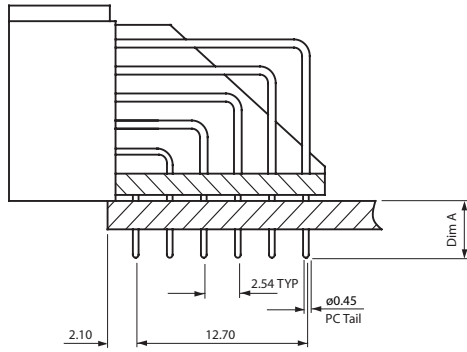

Dimensions applicable to 3, 4 and 5 row insulators also.

MALE 90° PCB

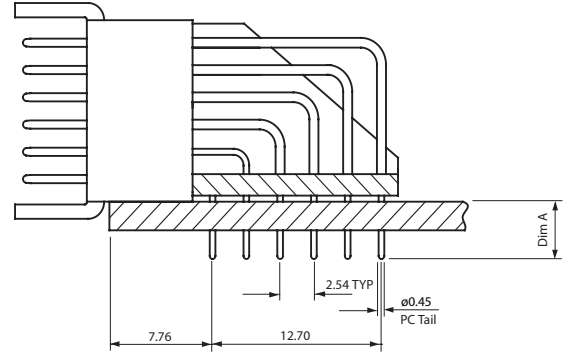

Dimensions applicable to 3, 4 and 5 row insulators also.

TERMINATION	Dim. A
Bπ	2.85 0.112"
L#	4.00 0.157"

* Off the shelf # Off the shelf Male Ω Off the shelf Female † Subject to availability π Made to order

FEMALE VERTICAL PCB

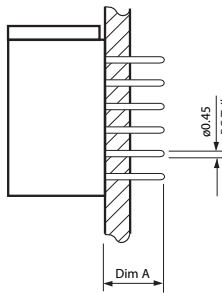

MALE VERTICAL PCB

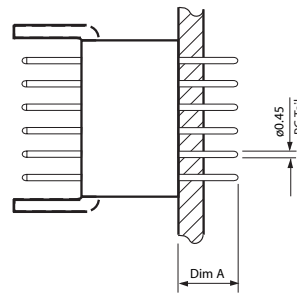

TERMINATION	Dim. A
P*	4.50 0.117"
KΩ	6.70 0.246"

* Off the shelf # Off the shelf Male Ω Off the shelf Female † Subject to availability π Made to order

Dimensions are in mm

HPH cable terminations

MALE CRIMP CONTACT (26 -22 AWG)

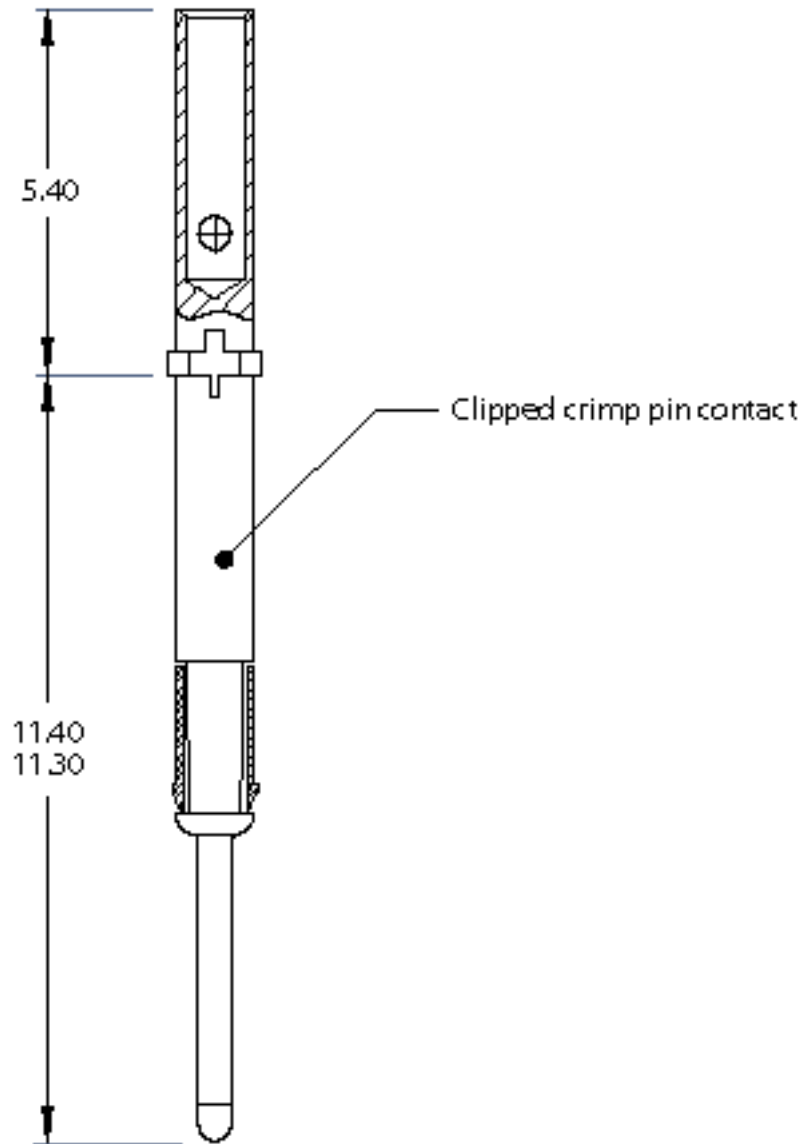

Consult our sales offices for tooling requirements

HPH standard guides male/female

FEMALE GUIDE INDEX

Style AU	Stacking	Non-polarised;	Vertical mounting;	1/10
Style HA		Polarised;	Vertical mounting;	1/10
Style HD		Polarised;	Vertical mounting;	1/10
Style HN		Polarised;	Vertical mounting;	1/10
Style SC	Jack socket;	Non-polarised;	Vertical mounting;	1/10
Style TJ	T-Jack socket;	Non-polarised;	Transverse mounting;	1/10
Style TP	T-Jack socket;	Non-polarised;	Transverse mounting;	1/10
Style TT	T-Jack socket;	Non-polarised;	Transverse mounting;	1/10

MALE GUIDE INDEX

Style AT	Stacking;	Non-polarised;	Vertical mounting;	1/11
Style PE	T-bracket;	Polarised;	Transverse mounting;	1/11
Style PF	T-bracket;	Polarised;	Transverse mounting;	1/11
Style PG	T-bracket;	Polarised;	Transverse mounting;	1/11
Style PN	T-bracket;	Polarised;	Transverse mounting;	1/11
Style PP	T-bracket;	Polarised;	Transverse mounting;	1/11
Style PQ	T-bracket;	Polarised;	Transverse mounting;	1/11
Style PT	T-bracket;	Polarised;	Transverse mounting;	1/11
Style QC	L-bracket;	Polarised;	Transverse mounting;	1/11
Style QF	L-bracket;	Polarised;	Transverse mounting;	1/11
Style QQ	L-bracket;	Polarised;	Transverse mounting;	1/11
Style Q3	L-bracket;	Polarised;	Transverse mounting;	1/11
Style 3C	Jacking;	Non-polarised;	Rotating free connector;	1/11
Style 3F	Jacking;	Non-polarised;	Vertical mounting;	1/12
Style NA		Polarised;	Vertical mounting;	1/12
Style NB		Polarised;	Vertical mounting;	1/12

MALE GUIDES

	AT	PE	PF	PG	PN	PP	PQ	PT	QC	QF	QQ	Q3	3C	3F	NA	NB
FEMALE GUIDES	AU															
	HA															
	HD															
	HN															
	SC															
	TJ															
	TP															
	TT															

**Note: For pin carrier guides please refer to:
HPH Insulators / Pin Carrier /Guides**

HPH standard guides female

Style AU

Non Polarized Vertical Mounting Stacking

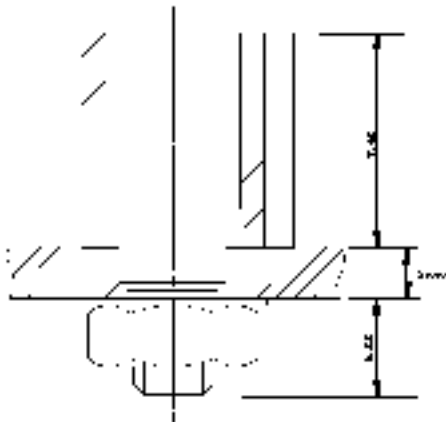

Style T

Jack Socket Non Polarized Transverse Mounting T Bracket

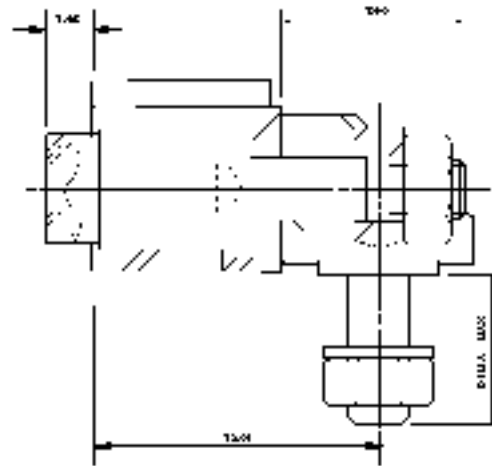

Style 3160A	1.1	
Style 4160A		1.1
Style 5160A		1.1
Board thickness	2.54 0.100"	3.20 0.126"
Dim A max	3.74 0.147"	4.54 0.179"

Above guides can also be used for male connectors

Style H

Polarized Vertical Mounting

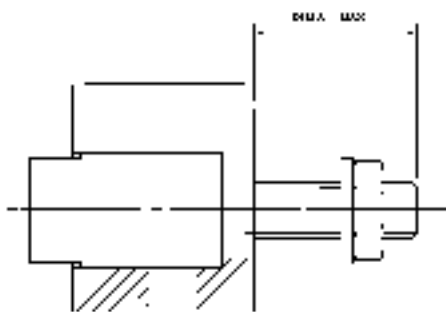

Style SC

Jack Socket Non Polarized Vertical Mounting

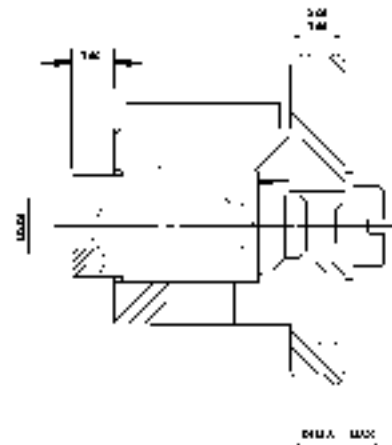

Style	Board thickness	Dim A max
HA	2.54 0.100"	4.54 0.179"
HD	3.20 0.126"	7.24 0.285"
HN	4.00 0.157"	9.04 0.354"

Style	Board thickness	Dim A max
SC	2.54 0.100"	4.54 0.179"

Dimensions are in mm

HPH standard guides male

Style AT

Non Polarised Vertical Mounting Stacking

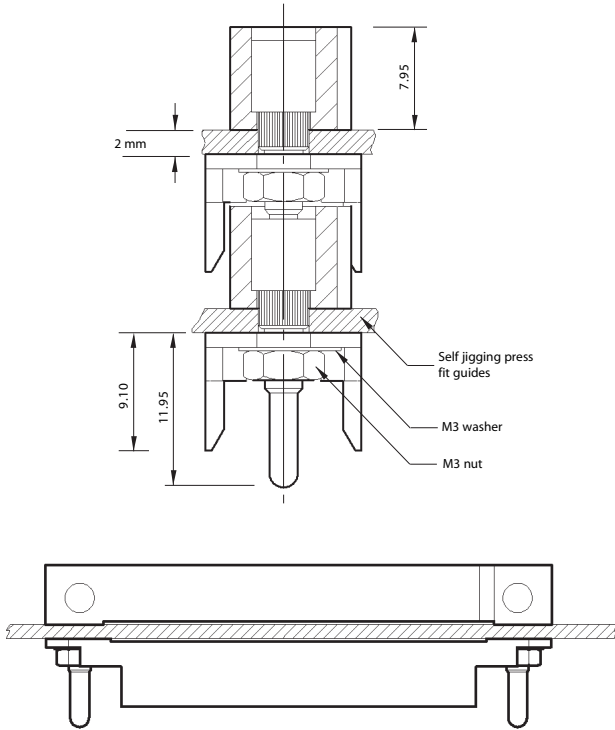

Style P

Polarised Transverse Mounting
(showing 5 row style)

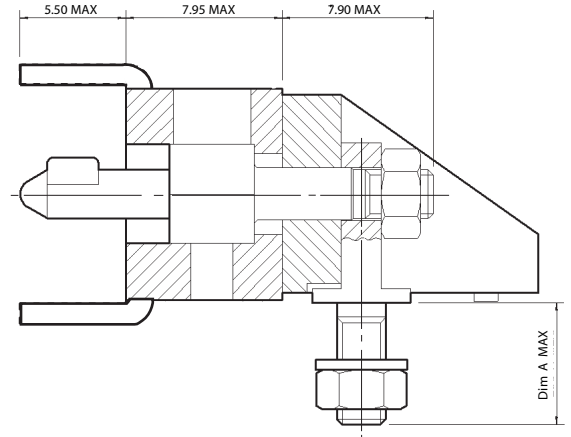

STYLE	No. of Rows	Board Thickness	Dim. A max.
PE/PF/PG	3/4/5	2.00 0.078"	5.10 0.200"
PN/PP/PQ	3/4/5	3.20 0.125"	6.30 0.248"
PT	6	2.60 0.102"	5.70 0.224"

Style Q

Polarised Transverse Mounting L Bracket

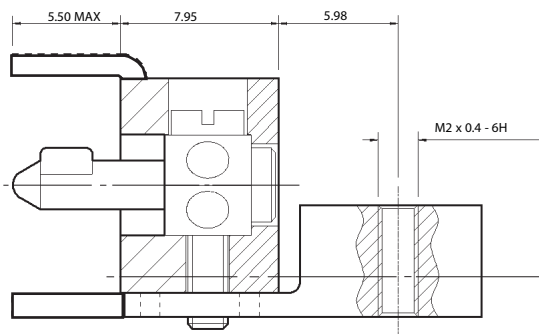

Style 3 Row	Style 4 Row	Style 5 Row	Style 6 Row	Board Thickness
QC	QF	QQ		2.54 0.100"
			Q3	3.20 0.393"

Style 3C

Jacking Guide Non-polarised
Rotating Free Connector

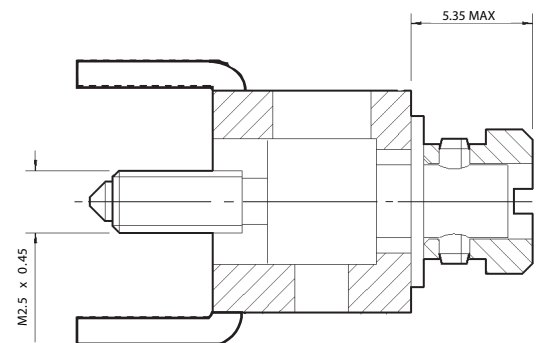

Dimensions are in mm

HPH standard guides male

Style 3F

Jacking Guide Non-polarized
Vertical Mounting

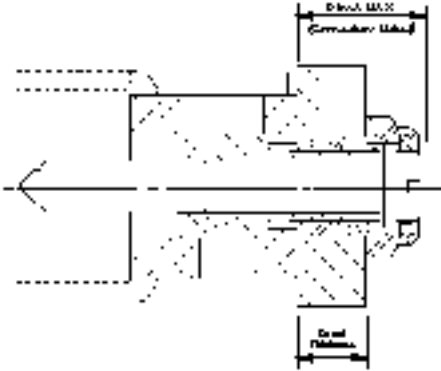

Style	Board Thickness	Dim A max
3F	2.54 - 3.43 0.100" - 0.135"	4.25 0.168"

Style N

Polarized Vertical Mounting



Style	Board Thickness	Dim A max
NA	2.54 0.100"	4.95 0.195"
NB	3.03 0.120"	5.08 0.201"

Dimensions are in mm

HPH PCB preparation details

Important: Please allow the following clearance dimensions around all 90° PCB layout configurations to accommodate the alignment comb shown below.

PCB 90° ALIGNMENT COMB DETAILS

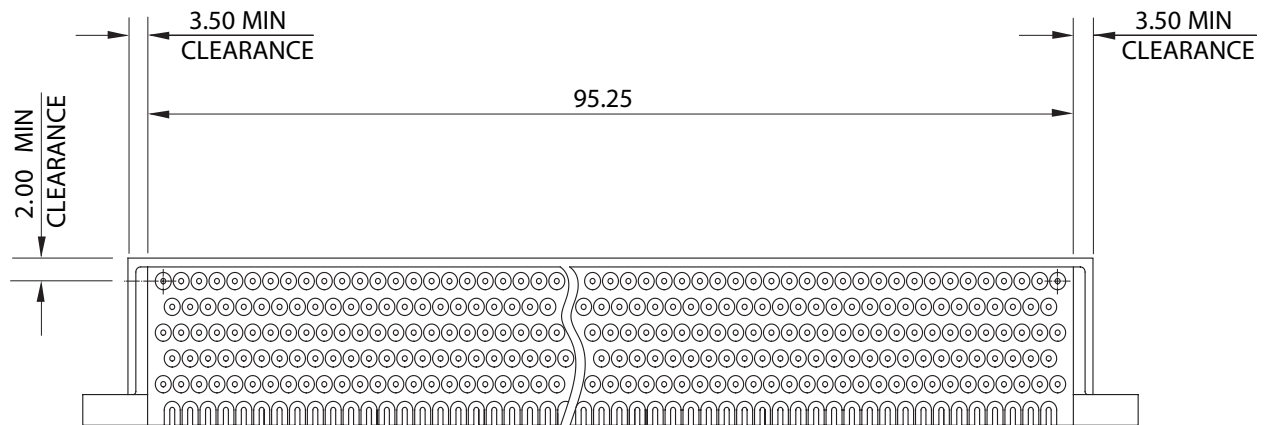

303 way showing typical clearance dimensions (applies to all 90° styles).

HPH PCB standard 90° preparations details

20 WAY 90° PCB LAYOUT

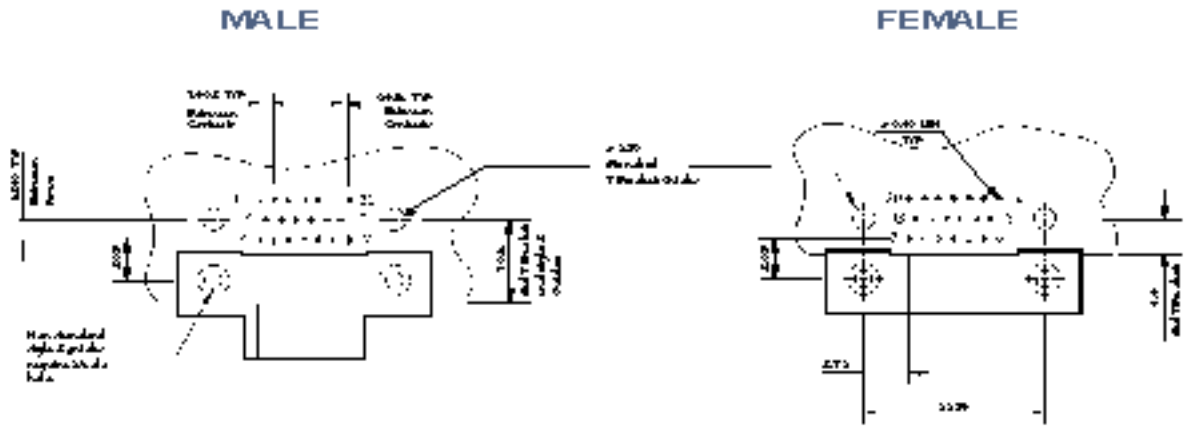

50 WAY 90° PCB LAYOUT

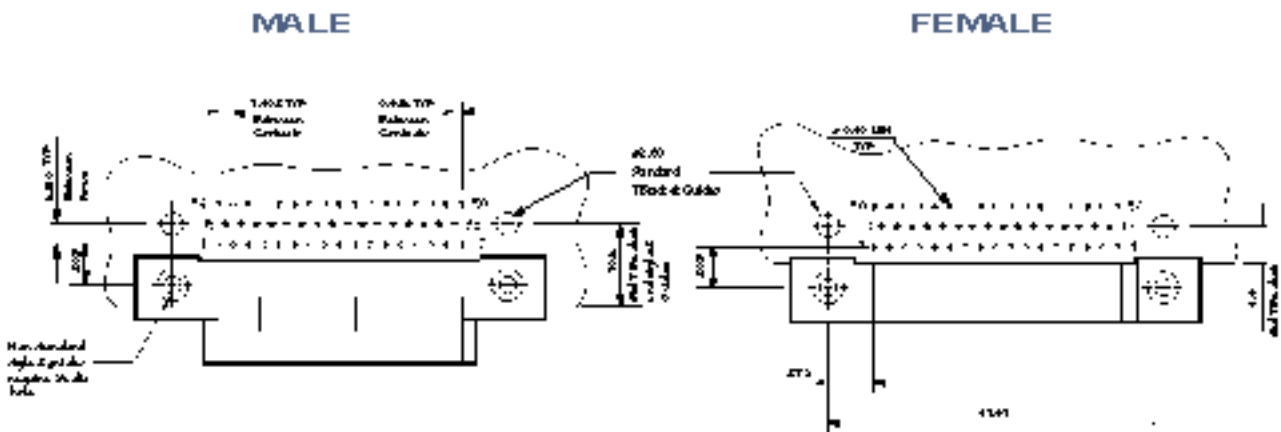

77 WAY 90° PCB LAYOUT

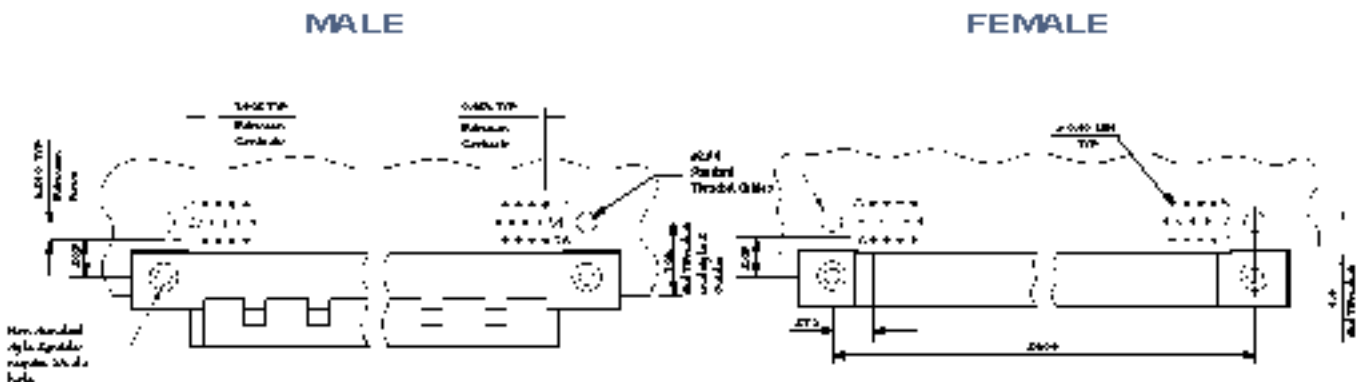

Dimensions are in mm

HPH PCB standard 90° preparations details

102 WAY 90° PCB LAYOUT

MALE

FEMALE

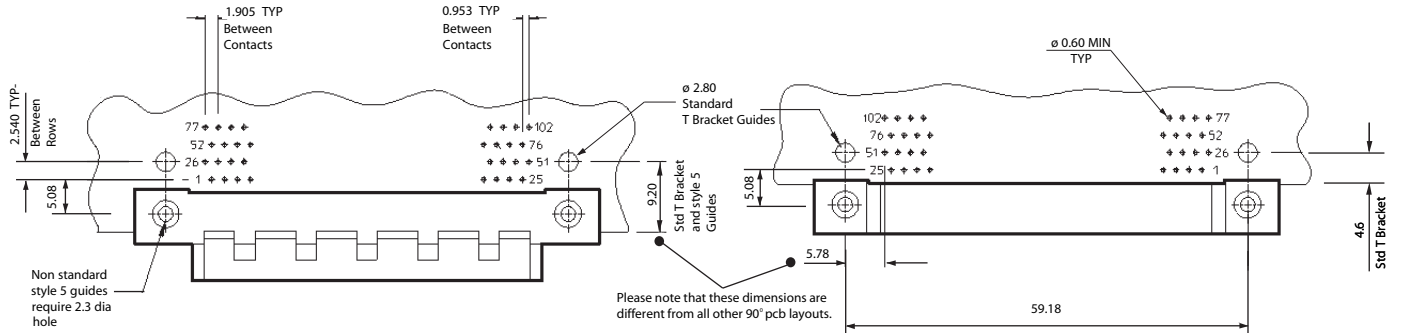

119 WAY 90° PCB LAYOUT

MALE

FEMALE

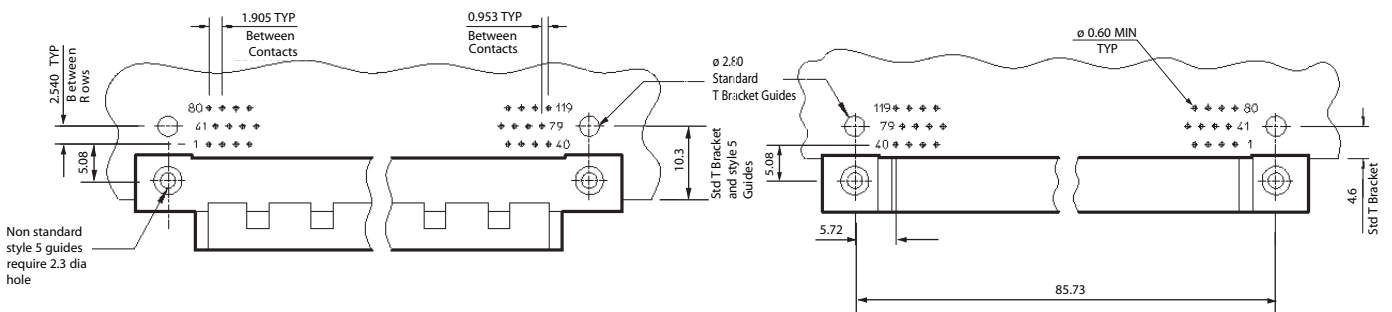

128 WAY 90° PCB LAYOUT

MALE

FEMALE

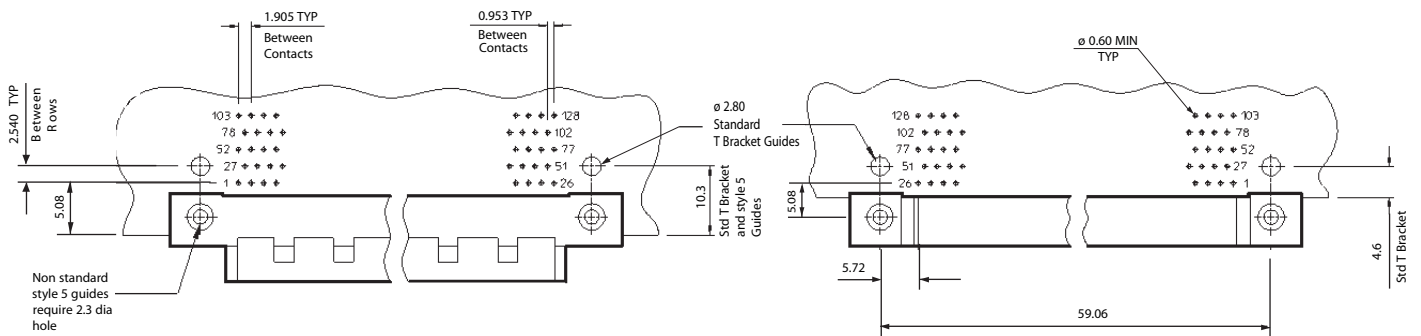

Dimensions are in mm

HPH PCB standard 90° preparations details

152 WAY 90° PCB LAYOUT

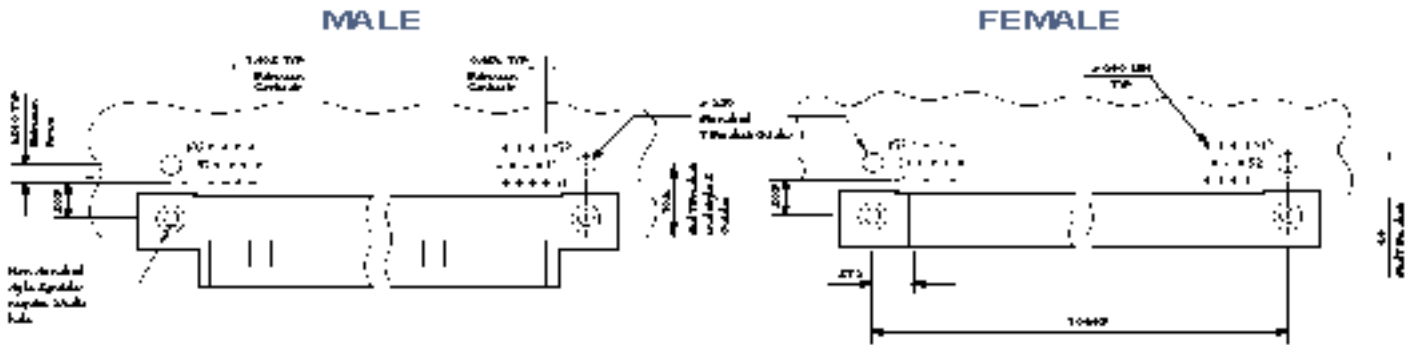

202 WAY 90° PCB LAYOUT

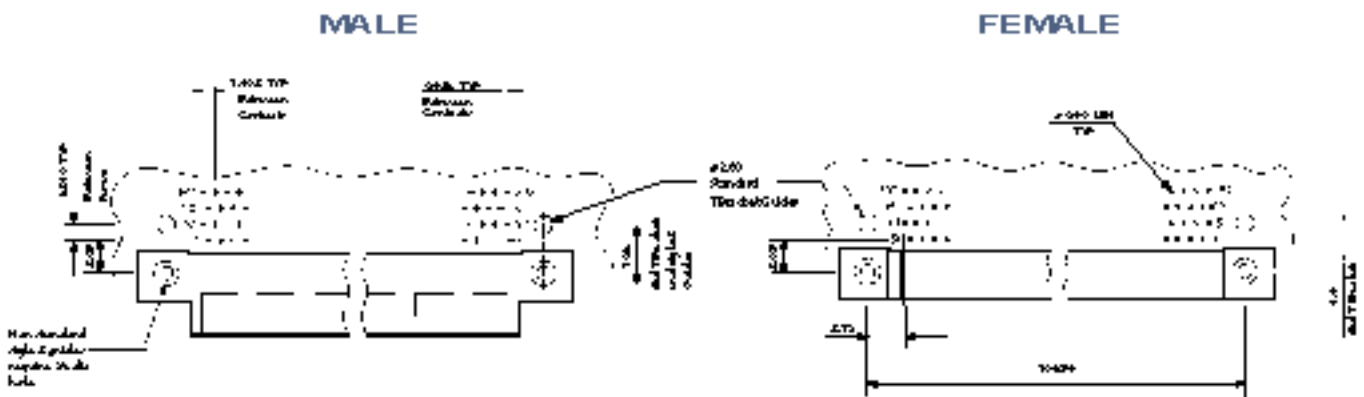

253 WAY 90° PCB LAYOUT

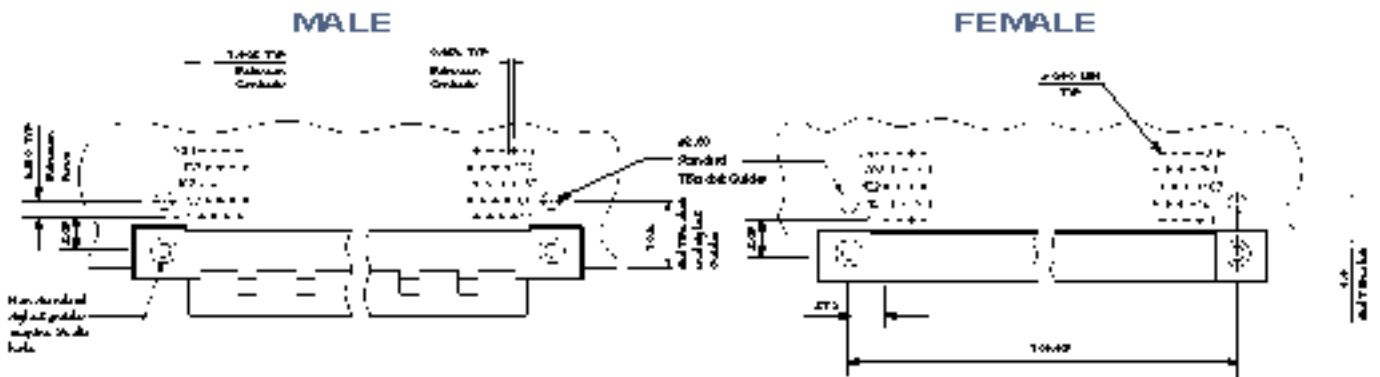

303 WAY 90° PCB LAYOUT

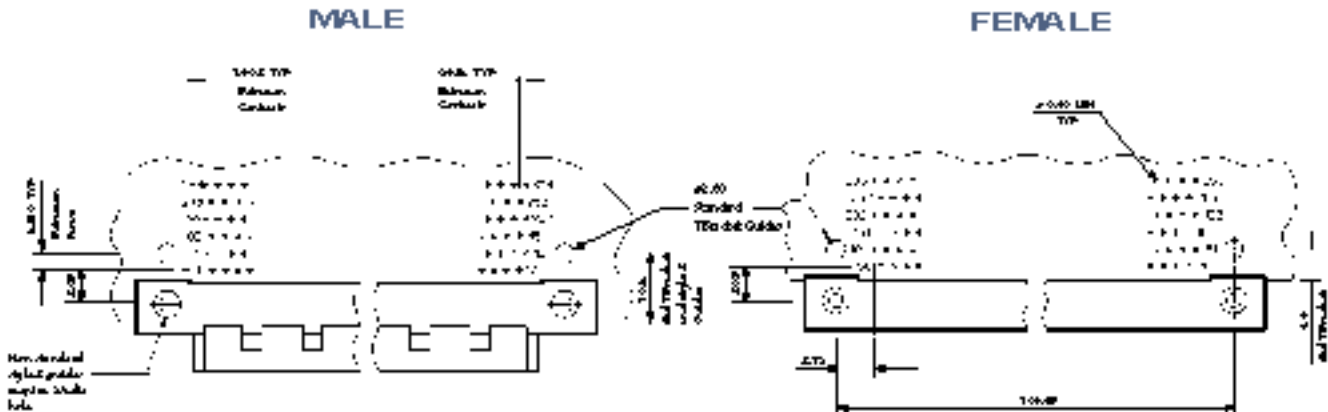

Dimensions are in mm

HPH PCB standard vertical preparations details

NOTE: VERTICAL GUIDE CENTRES ALIGN WITH THE CENTRE OF THE PCB CONTACT LAYOUT.

20 WAY VERTICAL PCB

LAYOUT MALE

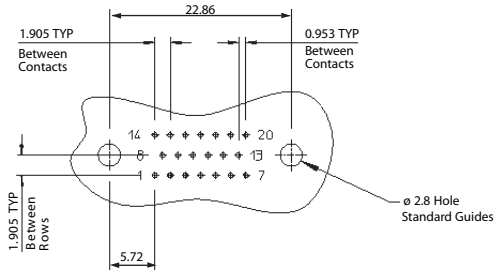

LAYOUT FEMALE

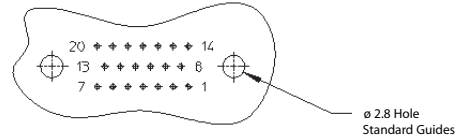

50 WAY VERTICAL PCB

LAYOUT MALE

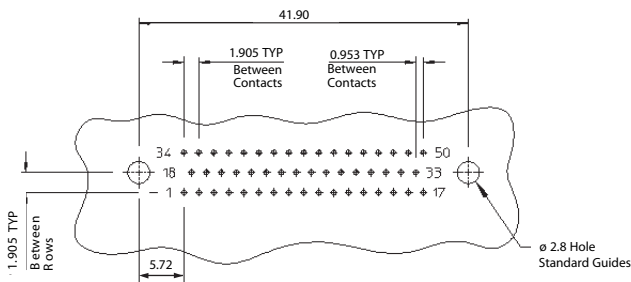

LAYOUT FEMALE

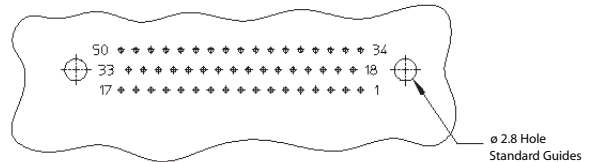

77 WAY VERTICAL PCB

LAYOUT MALE

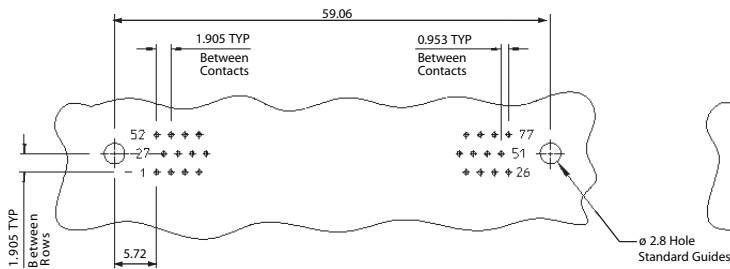

LAYOUT FEMALE

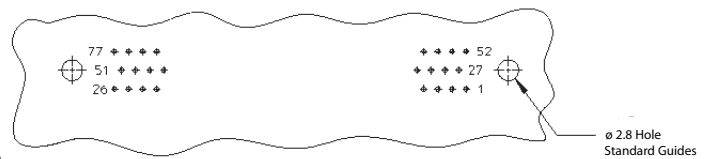

Dimensions are in mm

HPH PCB standard vertical preparations details

NOTE: VERTICAL GUIDE CENTRES ALIGN WITH THE CENTRE OF THE PCB CONTACT LAYOUT.

102 WAY VERTICAL PCB



119 WAY VERTICAL PCB

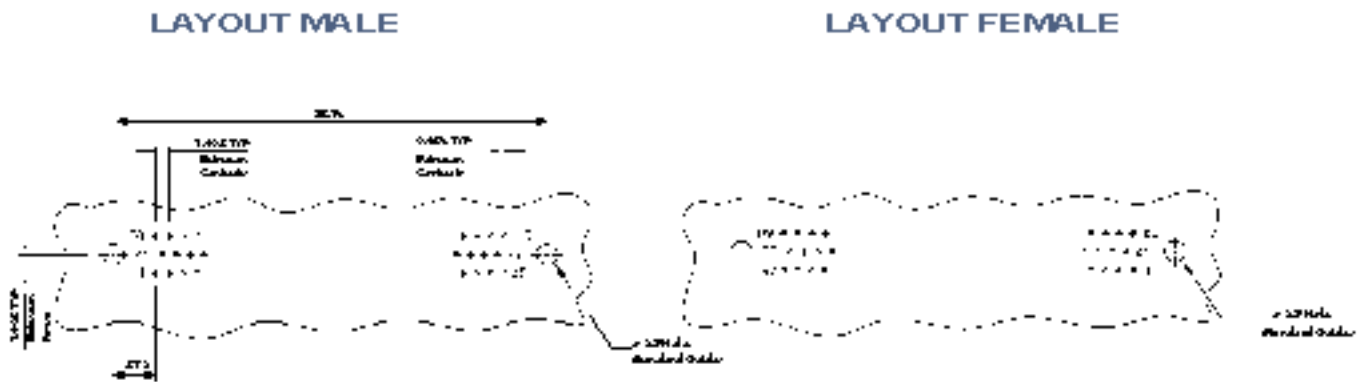

128 WAY VERTICAL PCB

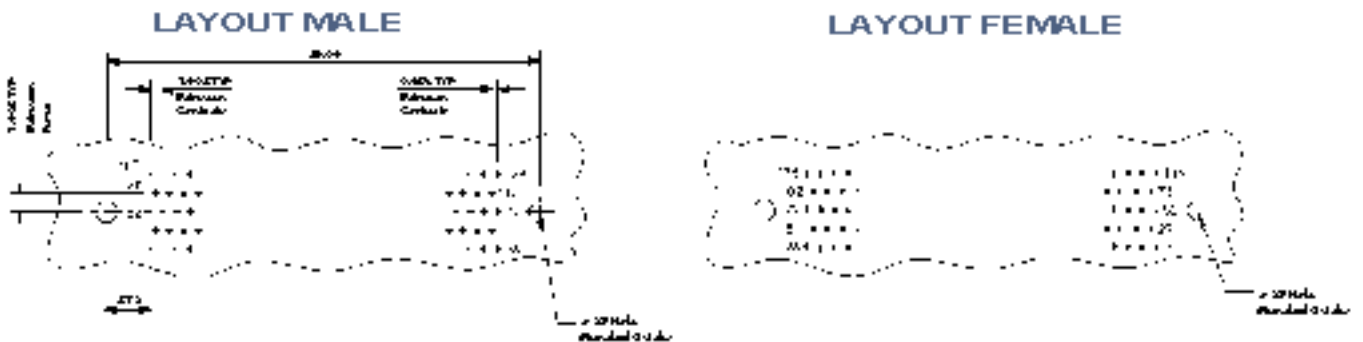

Dimensions are in mm

HPH PCB standard vertical preparations details

NOTE: VERTICAL GUIDE CENTRES ALIGN WITH THE CENTRE OF THE PCB CONTACT LAYOUT.

152 WAY VERTICAL PCB

LAYOUT MALE

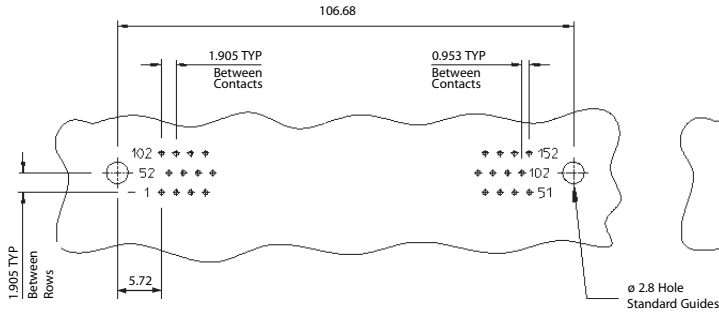

LAYOUT FEMALE

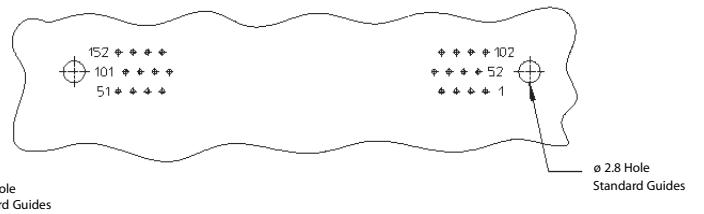

202 WAY VERTICAL PCB

LAYOUT MALE

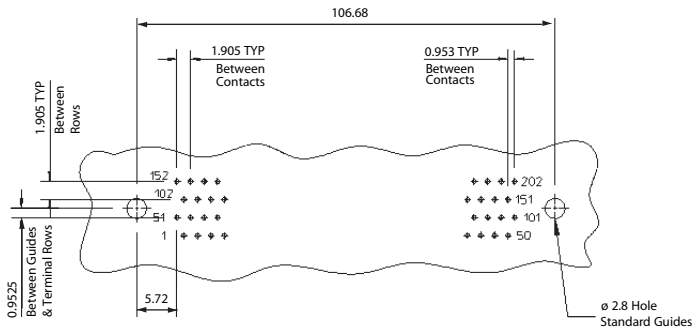

LAYOUT FEMALE

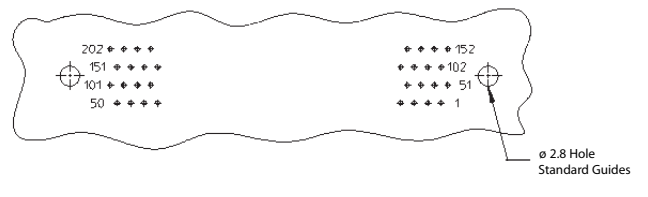

253 WAY VERTICAL PCB

LAYOUT MALE

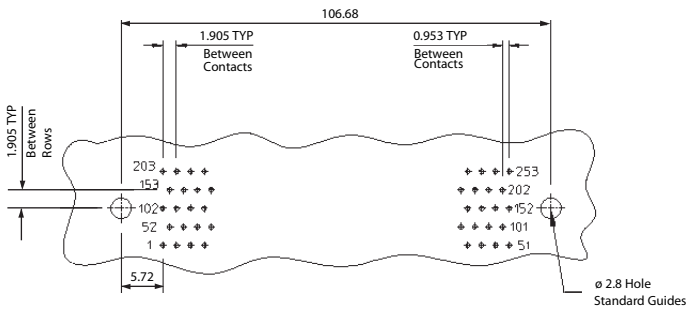

LAYOUT FEMALE

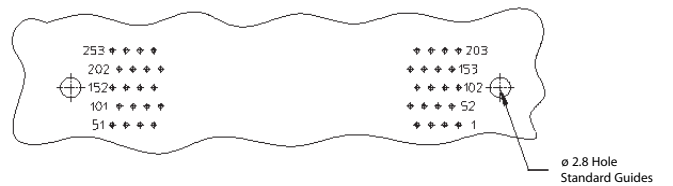

303 WAY VERTICAL PCB

LAYOUT MALE

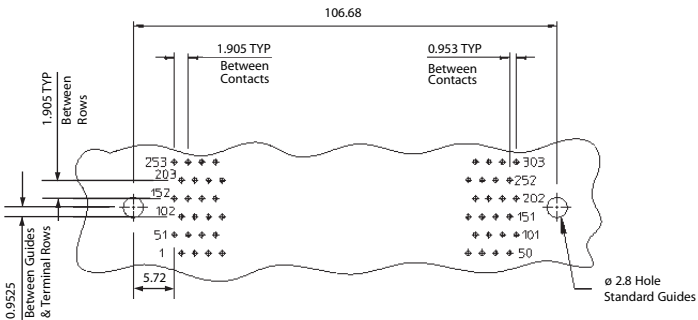

LAYOUT FEMALE

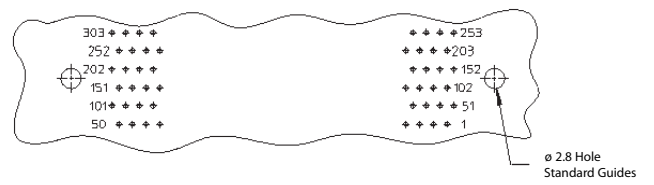

Dimensions are in mm

HPH PCB stacking preparations details

NOTE: STACKING GUIDE CENTRES ALIGN WITH THE CENTRE OF THE PCB CONTACT LAYOUT.

50 WAY VERTICAL PCB

LAYOUT VIEWED FROM MALE SIDE

LAYOUT VIEWED FROM FEMALE SIDE

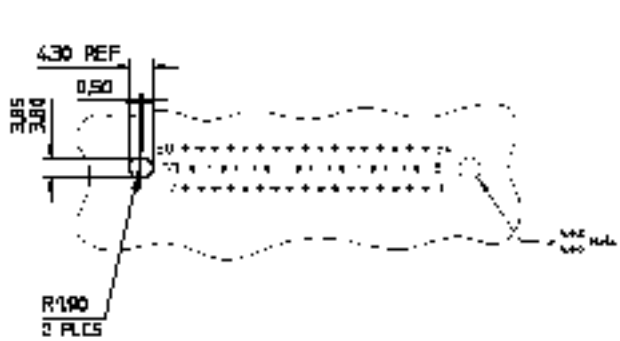
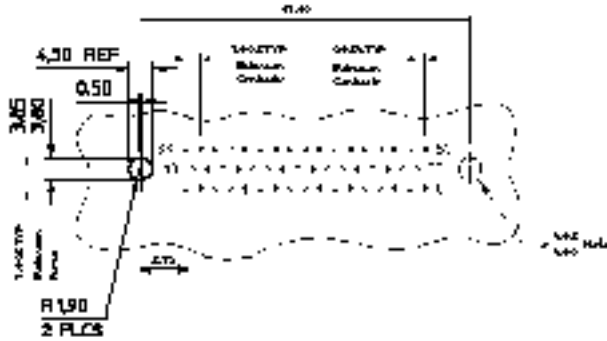
77 WAY VERTICAL PCB

LAYOUT VIEWED FROM MALE SIDE

LAYOUT VIEWED FROM FEMALE SIDE

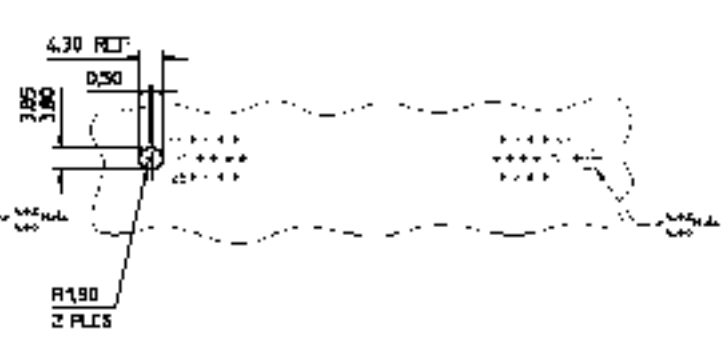
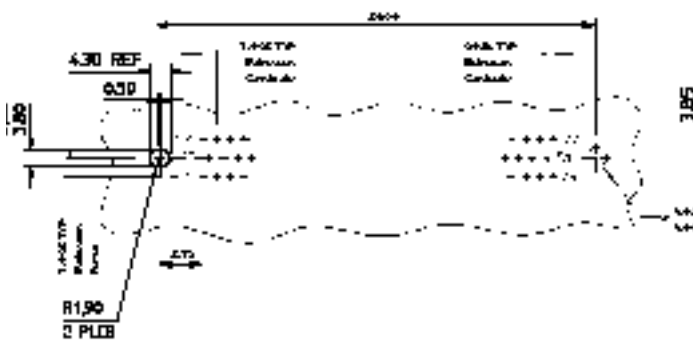
102 WAY VERTICAL PCB

LAYOUT VIEWED FROM MALE SIDE

LAYOUT VIEWED FROM FEMALE SIDE

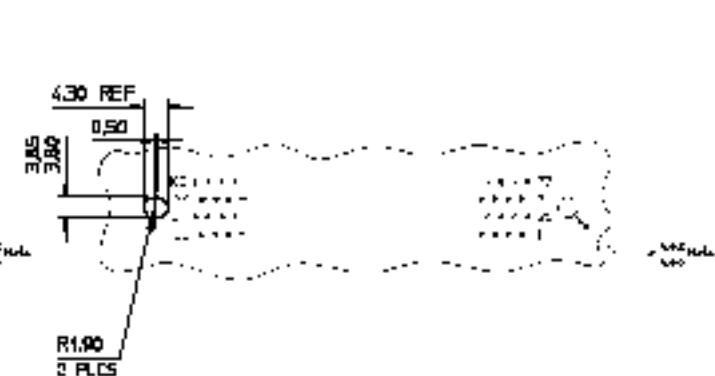
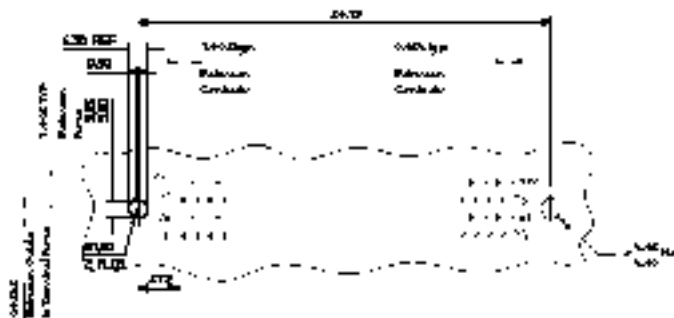

Stacking connectors are currently only available in 50, 77 & 102 ways.

If you have further requirements please contact our local sales offices.

Dimensions are in mm